

POWER PROTECTION



PowerSure™ Interactive

**700-2200 VA
120 V**

USER MANUAL English



IMPORTANT SAFETY INSTRUCTIONS

WARNING: Do not attempt to service this product yourself except to replace the battery. Opening or removing the cover may expose you to dangerous voltages, even when the AC cord is disconnected from the electrical outlet. Refer all servicing to qualified service personnel.

1. **SAVE THESE INSTRUCTIONS.** THIS MANUAL CONTAINS IMPORTANT INSTRUCTIONS THAT SHOULD BE FOLLOWED DURING INSTALLATION AND MAINTENANCE OF THE UNINTERRUPTIBLE POWER SYSTEM (UPS) AND BATTERIES.
CONSERVER CES INSTRUCTIONS. CETTE NOTICE CONTIENT DES INSTRUCTIONS IMPORTANTES CONCERNANT LA SÉCURITÉ.
2. **This product is not intended for use with life support and other U.S. FDA designated “critical” devices. See Limited Warranty.**
3. **CAUTION:** A BATTERY PRESENTS A RISK OF ELECTRICAL SHOCK OR BURN FROM HIGH SHORT CIRCUIT CURRENT. OBSERVE PROPER PRECAUTIONS.
ATTENTION: UNE BATTERIE PRESENT UN RESQUE DE CHOC ÉLECTRIQUE OU DE BRÛLURE PAR TRANSFERT D'ÉNERGIE. SUIVRE LES PRÉCAUTIONS QUI S'IMPOSENT.
4. WHEN REPLACING THE BATTERIES, USE THE SAME NUMBER AND TYPE OF BATTERIES. PROPER DISPOSAL OF BATTERIES IS REQUIRED. REFER TO YOUR LOCAL CODES FOR DISPOSAL REQUIREMENTS.
POUR LE REMPLACEMENT, UTILISER LE MÊME NOMBRE ET TYPE DE BATTERIES. L'ÉLIMINATION DES BATTERIES EST RÉGLE-MENTÉE. CONSULTER LES CODES LOCAUX À CER EFFET.
5. Read all safety and operating instructions before operating the UPS. Adhere to all warnings on the unit and in this manual. Follow all operating and user instructions.
6. Turn the UPS off and unplug it before cleaning. Use only a soft cloth, never liquid or aerosol cleaners.
7. The UPS is designed for data processing equipment. Do not plug appliances, such as hair dryers, heaters, vacuum cleaners, or electric drills, into the UPS output receptacles.
8. **WARNING:** Do not modify input cable. Consult your dealer if connector does not match the utility receptacle. The UPS must be grounded at all times while in use. Turn the UPS off before unplugging

it, or the safety ground will be removed. Operate UPS only from a properly grounded 120 VAC outlet (2 wire plus ground).

9. The UPS is equipped with a grounded NEMA 5-15P or L5-30P input power plug (depending upon model). Do not defeat the safety purpose of this plug. If unable to fully insert the plug into the wall outlet, contact a qualified electrician for assistance.
10. Route power supply cords so they are not walked on or pinched.
11. Never block or insert any object into the ventilation holes or other openings. Maintain a clearance of four (4) inches (102 mm) around the UPS for proper air flow and cooling.
12. Always turn off the UPS and unplug it before starting the battery replacement procedure. Servicing of batteries should be performed or supervised by personnel knowledgeable of batteries and the required precautions. To replace batteries, refer to the battery replacement procedure. If you feel unqualified to replace the batteries, do not open the battery door. Refer all servicing to qualified service personnel.
13. **CAUTION:** Do not open or mutilate the batteries. Released electrolyte is harmful to skin and eyes and may be toxic.

INTRODUCTION & SYSTEM DESCRIPTION

Congratulations on your choice of the Liebert PowerSure™ Interactive Uninterruptible Power System (UPS). It provides conditioned power to microcomputers and other sensitive electronic equipment.

Upon generation, AC power is clean and stable. However, during transmission it may be subject to voltage sags, spikes, or complete power failure which may interrupt computer operations, cause data loss, or even damage equipment. The PowerSure™ Interactive protects equipment from these disturbances.

The PowerSure™ Interactive comes in nominal power ratings of 700, 1000, 1400, or 2200 VA. Complete specifications appear near the end of this section.

The PowerSure™ Interactive is a compact, "line interactive" UPS. A "line interactive" UPS continuously conditions and regulates its output voltage, whether the utility power is present or not. It supplies connected equipment with clean sinewave power, to simulate as much as possible, the power generated by the utility. Sensitive electronic equipment operates best from sinewave power.

For ease of use, the PowerSure™ Interactive contains a light emitting diode (LED) bar display to indicate "load percentage" or "battery capacity" depending upon the mode of operation. It also provides self diagnostics, a combination alarm silence/battery test button, and two levels of alarms when the unit is operating on battery.

The PowerSure™ Interactive has an interface port for communications between the UPS and a LAN server or other computer system. This port provides detailed operating information including voltages, currents, and alarm status to the host system when used in conjunction with Liebert SiteNet® software. SiteNet® software can also remotely control UPS operation.

CAUTION: This equipment has been tested and complies with limits for a Class A digital device, pursuant to Subpart B of Part 15 of FCC rules. These limits provide reasonable protection against harmful interference when the equipment is operated in a commercial environment. This equipment generates, uses, and can radiate radio frequency energy. If it is not installed and used in accordance with the instruction manual, it may cause harmful interference to radio communications. Operation of this equipment in a residential area is likely to cause harmful interference which the user must correct at his own expense.

MAJOR COMPONENTS

TRANSIENT VOLTAGE SURGE SUPPRESSION (TVSS) AND EMI/RFI FILTERS

These UPS components provide surge protection and filter Electromagnetic Interference (EMI) and Radio Frequency Interference (RFI). They minimize any surges or interference present in the utility line and keep the sensitive equipment protected.

AUTOMATIC VOLTAGE REGULATOR

In normal operation, the Automatic Voltage Regulator (AVR) passes utility AC power to the connected load. When utility power voltage is outside acceptable limits, the AVR activates. It raises undervoltage power and lowers overvoltage power. This keeps the UPS output voltage within the connected equipment's tolerances and allows wide utility voltage fluctuations without utilizing battery power.

BI-DIRECTIONAL CONVERTER

In normal operation, the bi-directional converter "converts" utility AC power into regulated DC power to "float" charge the battery system. Upon a utility power failure, the bi-directional converter receives its required energy from the battery and "inverts" it into precise, regulated sinewave AC power. Charging takes place whenever the UPS is plugged into the wall outlet whether it is ON or OFF and utility power is within acceptable limits.

BATTERY

The PowerSure™ Interactive utilizes valve regulated, nonspillable, lead acid batteries. At typical room temperatures and with the UPS float charging, the battery system will last many years. For battery run times, refer to the Typical Battery Discharge Curves.

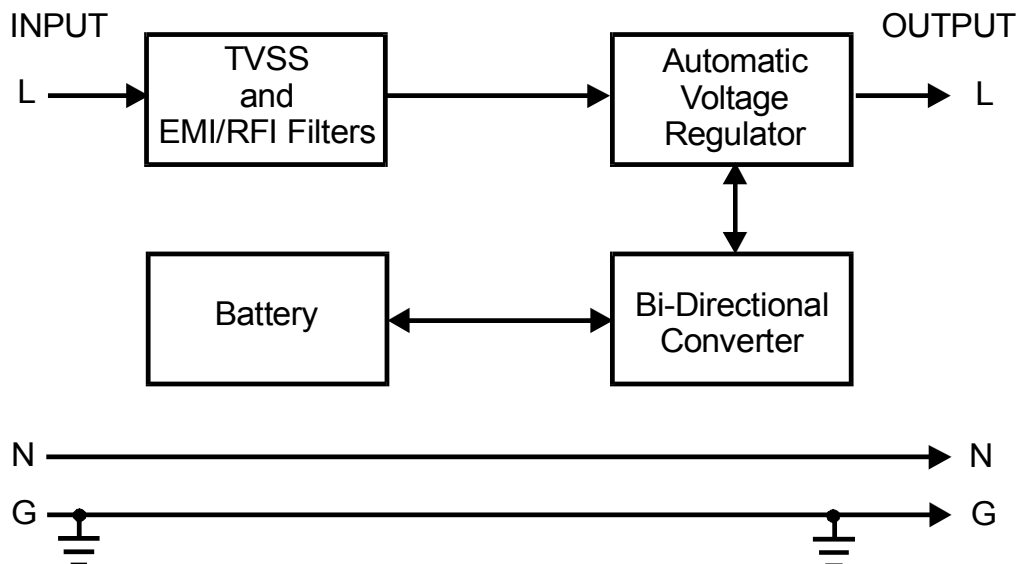

MINI-TOWER INSTALLATION

1. Unpack the UPS carefully noting the packing method. Retain the box and packing material for possible future shipment.

CAUTION: The UPS is heavy (see specifications). Take proper precautions when lifting or moving it.

2. Visually inspect the UPS for freight damage. Report damage to the carrier and your dealer.
3. Locate the UPS indoors where it cannot be accidentally disconnected. Locate it in an area with unrestricted airflow, away from water, flammable liquids, gases, corrosives, or conductive contaminants. Maintain a minimum of four (4) inches (102 mm) clearance around the UPS. Maintain an ambient temperature range of 32° to 104° F (0° to 40° C).

NOTE: UPS operation in temperatures above 77° F (25° C) reduces battery life.

4. Ensuring load equipment is turned off, plug all loads into the UPS output receptacles.
5. Plug the UPS into a dedicated wall receptacle properly protected by a circuit breaker or fuse in accordance with the National Electric Code (ANSI/NFPA 70) or local codes. Use a 15 amp rated device for the 700, 1000, or 1400 VA units, and a 30 amp device for the 2200 VA unit. The wall receptacle must be grounded.
6. Turn on the UPS, by pressing the On/Off button, then turn on the connected load equipment. The UPS is ready for normal operation.

RACKMOUNT INSTALLATION

1. Unpack the UPS carefully noting the packing method. Retain box and packing material for possible future shipment.

CAUTION: The UPS is heavy (see specifications). Take the proper precautions when lifting or moving the UPS.

2. Visually inspect the UPS for freight damage. Report any damage to the carrier and your dealer.
3. Locate the UPS indoors where it cannot be accidentally disconnected. Locate it in an area with unrestricted airflow, away from water, flammable liquids, gases, corrosives, or conductive contaminants. Maintain a minimum of four (4) inches (102 mm) clearance in front and rear of the UPS. Maintain an ambient temperature range of 32° to 104° F (0° to 40° C).

NOTE: UPS operation in temperatures above 77° F (25° C) reduces battery life.

4. Gently lay UPS on its bottom side so that the front bezel is facing you.
5. The Rackmount UPS must be supported by a shelf or rails. The front bezel will not support the weight of the UPS.

CAUTION: To increase the stability of the rack enclosure, place the UPS in the lowest possible rack position.

6. Refer to the Installation instructions supplied with the Rack Slide or Shelf Kits to complete the installation procedures.
7. After the UPS has been installed in the Rack enclosure, plug the UPS into a dedicated wall receptacle properly protected by a circuit breaker or fuse in accordance with the National Electric Code (ANSI/NFPA 70) or local codes. Use a 15 amp rated device for the 700, 1000, or 1400 VA units, and a 30 amp device for the 2200 VA unit. The wall receptacle must be grounded.
8. Ensuring load equipment is turned off, plug all loads into the UPS output receptacles.
9. Turn on the UPS, by pressing the On/Off button, then turn on the connected load equipment. The UPS is ready for normal operation.

CONTROLS AND INDICATORS

On/Off Button

The On/Off button controls output power to connected load(s).

CAUTION: Pressing the On/Off button when AC utility is not present will cause the UPS to begin operating from battery. This should not be performed unless the UPS input is connected to a properly grounded receptacle.

Load/Battery Level Indicators (ALL GREEN)

The Load/Battery Level Indicators have dual functions. During normal mode operation, LED indicators display electrical load placed upon the UPS; and during battery mode operation, LED indicators display battery capacity remaining. Each LED designates a 25% load or battery capacity increment. All four LED indicators illuminate at full load/battery capacity. If the UPS becomes loaded beyond full rating, the top LED indicator will flash continuously while an alarm sounds.

Utility/Battery Status Indicator (GREEN)

An illuminated LED indicates the power button is on and utility power is available. A flashing LED along with an alarm signifies utility voltage is out of specification and UPS is operating in battery mode.

Utility High/Low Indicator (AMBER)

An illuminated LED indicates the UPS is correcting utility power, due to a utility overvoltage or undervoltage condition.

Fault Indicator (GREEN)

The Fault indicator is the second uppermost LED (contained in load/battery level indicators). A flashing LED indicates the UPS has detected a problem. An alarm sounds to alert that the UPS requires attention. Refer to Troubleshooting Guide.

Alarm Silence/Battery Test Button

The Alarm Silence/Battery Test button serves a dual purpose. During normal mode operation, press button for at least one half second to test capacity of the battery system. The UPS will operate in battery mode for approximately 15 seconds. The illuminated LED indicators in Load/Battery Level determine battery mode capacity in 25% increments.

During battery mode operation or active alarm condition, this button functions as the alarm silence feature. Pressing this button for at least one half second will silence the alarm. After the alarm is silenced, the PowerSure™ Interactive will reactivate the alarm system to alert of additional problems. The low battery alarm is the single alarm that cannot be silenced.

During a Battery Test, if the top two LEDs do not illuminate allow the UPS to recharge the batteries for 24 hours. After 24 hours, retest the batteries. If the batteries have been retested and the top two LEDs still do not illuminate, contact your dealer or Liebert Technical Support (LTS) for a battery replacement kit.

Site Wiring Fault Indicator (RED)

An illuminated LED indicates the UPS has detected a miswired utility receptacle. Contact a qualified electrician for assistance.

POWERSURE™ INTERACTIVE MINI-TOWER

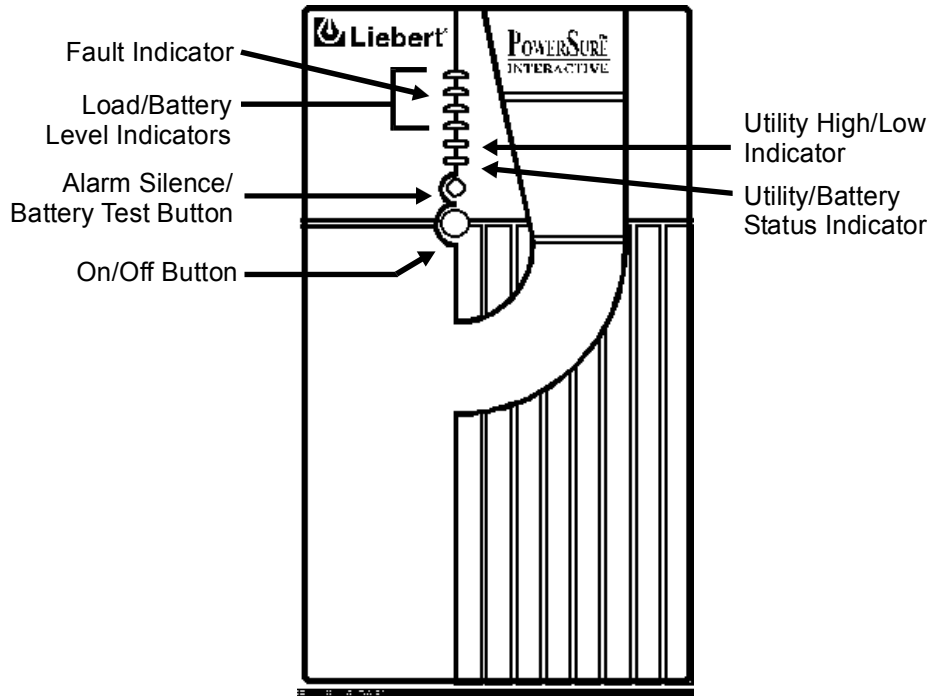

- 1- Output Receptacles
- 2- DB-9 Interface Port
- 3- AC Inlet
- 4- Intellislot™ Communications Port
- 5- Circuit Protector or Fuse
- 6- Site Wiring Fault Indicator

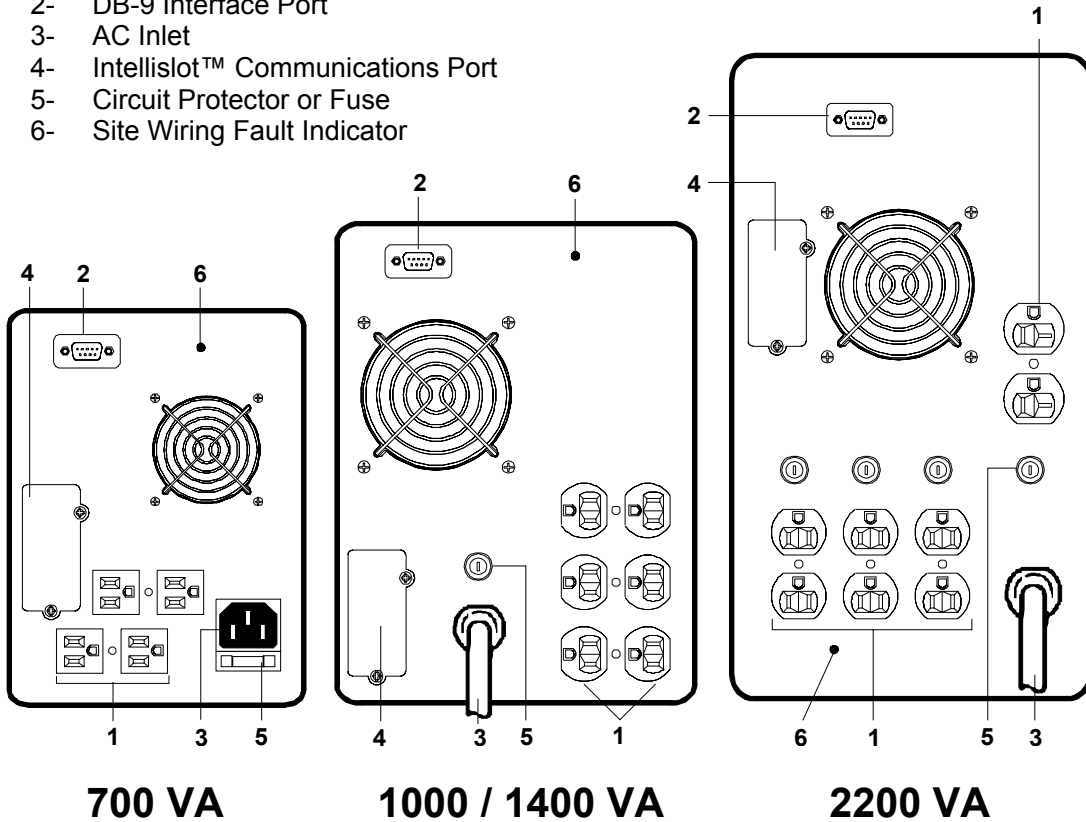

POWERSURE™ INTERACTIVE RACKMOUNT

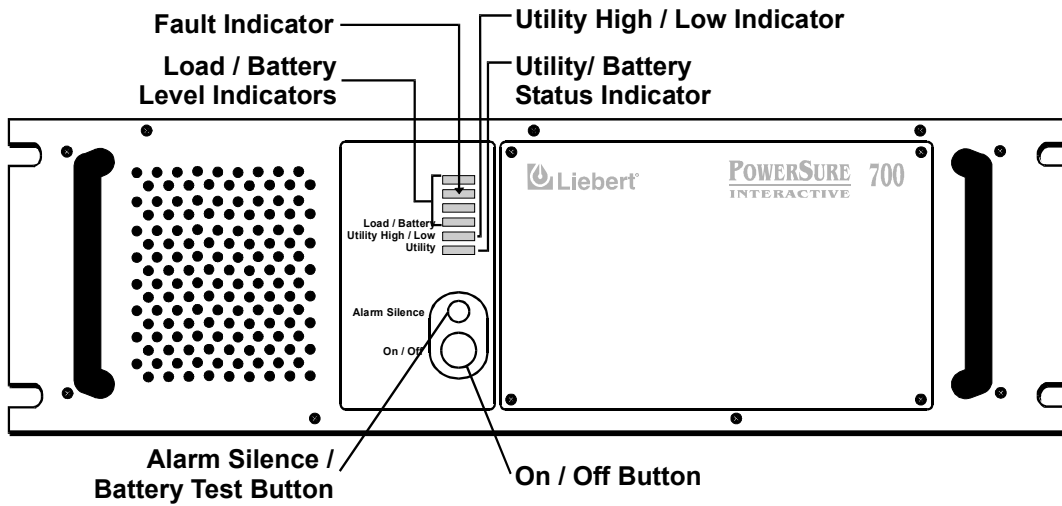

2200 Model

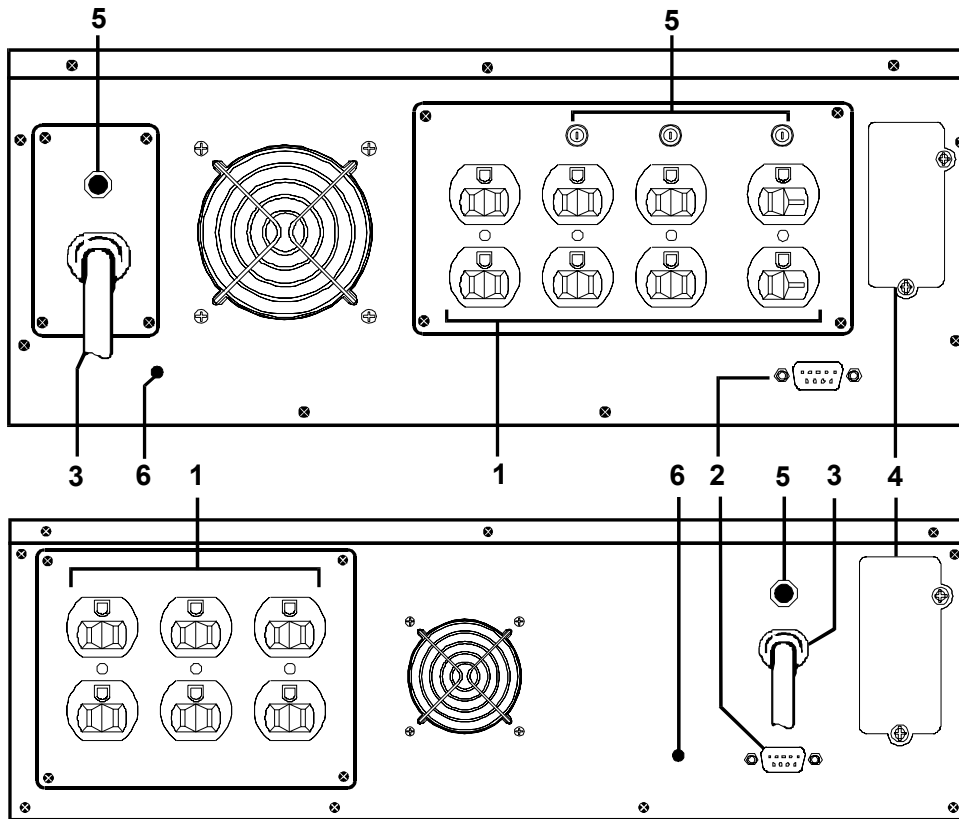

700-1400 Models

*700 Model has detachable cord

- 1- Output Receptacles
- 2- DB-9 Interface Port
- 3- AC Inlet
- 4- Intellislot™ Communications Port
- 5- Circuit Protector or Fuse
- 6- Site Wiring Fault Indicator

OPERATION

NORMAL MODE OPERATION

During normal operation, utility power provides energy to the UPS. The filters and the power conditioning circuit process this power to provide computer grade power to connected loads. The UPS maintains the batteries in a fully charged state.

The front panel displays the percentage of load on the UPS output. The figure below indicates approximately 51-75% loading.

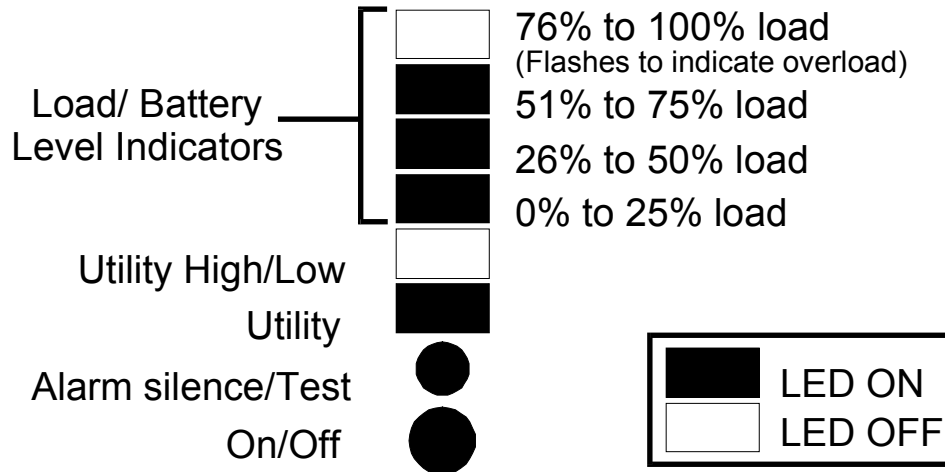

UTILITY HIGH/LOW MODE OPERATION

If high or low voltage conditions occur, the PowerSure™ Interactive UPS will automatically correct the utility voltage by either lowering or raising the input voltage condition. The UPS will continue to correct these conditions indefinitely, without draining battery power.

The figure below indicates approximately 51-75% loading while automatically correcting the utility voltage.

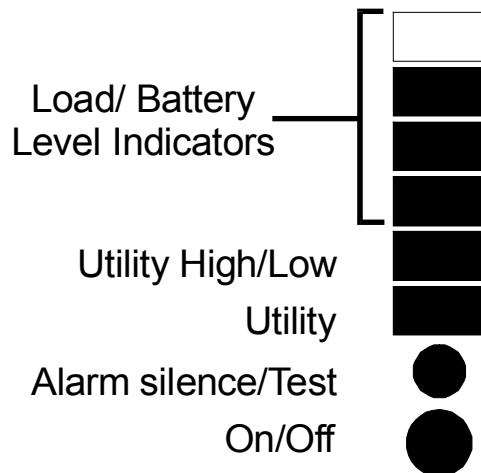

BATTERY MODE OPERATION

Battery mode occurs in event of extreme input conditions or complete utility failure. The battery system along with the bi-directional converter generates power for the connected load.

During battery mode an alarm sounds every 10 seconds. This will change to 2 beeps every 5 seconds when battery runs low (approximately 2 minutes remaining). Each load/battery level indicator represents a 25% capacity level. As capacity decreases, fewer indicators remain illuminated. Utility LED will flash every second indicating the UPS is operating from battery mode.

Battery mode supports a full rated load for approximately 5 minutes before it shuts down. To increase this time, turn off non essential pieces of equipment (such as idle computers and monitors).

WARNING: Turning off the UPS while in battery mode will result in loss of output power.

The figure below displays approximately 51-75% battery capacity remaining.

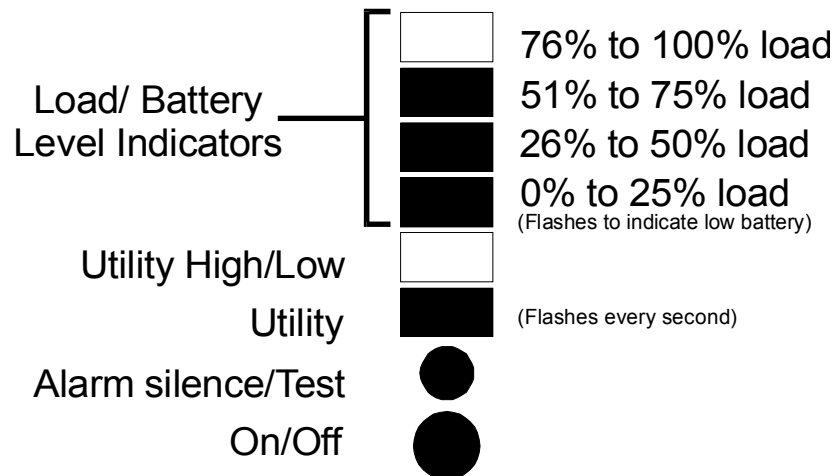

BATTERY RECHARGE MODE

The UPS resumes normal operation once utility power is restored. At this time, the bi-directional converter begins recharging the battery whether the UPS is ON or OFF.

COMMUNICATIONS INTERFACE PORT

The PowerSure™ Interactive UPS contains a standard DB-9F receptacle located on the rear of the UPS unit. Several signals are provided on this port and are assigned as follows:

PIN	ASSIGNMENT DESCRIPTION
1	Low Battery (open collector)
2	UPS TxD (typical RS-232 levels)
3	UPS RxD (typical RS-232 levels)
4	Remote Shutdown (5-12V DC, 1.0 mA. max.); battery operation
5	Common
6	No connection
7	Low Battery (open emitter)
8	Utility Fail (open emitter)
9	Utility Fail (open collector)

Pin Assignment

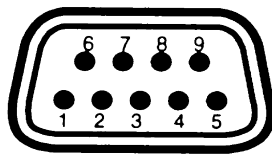

Collector to Emitter*

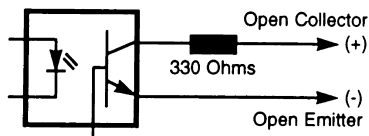

*Maximum voltage and current on pins 1, 7, 8, 9 is 80V DC; 10.0 mA.

UPS MONITORING

The PowerSure™ Interactive UPS has the capability of being monitored with stand alone computers, network workstations, network servers, or UNIX hosts via the DB-9 female connector located on the rear of the UPS.

This capability is used in applications requiring the UPS to provide status and power monitoring information to the computer system. For example, during a utility power failure, the information can be used by the computer's operating system or application program to automatically save information in buffers, to close files, and shut down operations prior to battery capacity depletion.

Monitoring of the UPS via a computer system is easily made with a Liebert SiteNet® 1 shutdown kit (sold separately). Consult your local Liebert representative to determine the correct software kit for your application. The kit includes special purpose cable and shutdown software.

UPS INTELLIGENT COMMUNICATIONS

The PowerSure™ Interactive UPS has the capability to communicate intelligently with stand alone computers, network workstations, network servers, or UNIX hosts via the DB-9 female connector located on the rear of the UPS. By purchasing the optional Liebert SiteNet® 2 software package (sold separately), intelligent communications allows the following capabilities:

- Quantitative monitoring of utility and UPS power
- Quantitative monitoring of internal UPS parameters
- Periodic tests of battery quality and replacement notification
- Timed and delayed shutdown of the UPS
- Logging of power disturbances and anomalies

Contact your local Liebert representative, dealer, or reseller for more information about SiteNet® 2 software.

UPS INTELLISLOT™ COMMUNICATIONS

The PowerSure™ Interactive UPS contains an Intellislot™ communications port for the optional internal communications, such as the Ethernet SNMP card. Optional SiteNet® SNMP Manager software is available to allow communication through several network management systems. Contact your local Liebert representative, dealer, or reseller.

CAUTION: TO MAINTAIN SAFETY (SELV) BARRIERS AND FOR ELECTROMAGNETIC COMPATIBILITY, SIGNAL CABLES SHOULD BE SEGREGATED AND SEPARATELY RUN FROM ALL OTHER POWER CABLES, WHERE APPLICABLE.

MAINTENANCE

The PowerSure™ Interactive UPS requires very little maintenance. The batteries are valve regulated, nonspillable, lead acid, and require that they be kept charged to obtain their designed life. Whether ON or OFF, the UPS continuously charges the batteries when connected to the utility supply.

When storing the UPS for any length of time, it is recommended to plug the UPS in for at least 24 hours every four to six months to ensure full recharge of the batteries.

The PowerSure™ Interactive UPS is designed to allow the user to safely replace the batteries. Read the safety cautions before proceeding. Contact your local Liebert representative, dealer, or reseller to obtain the appropriate replacement battery kit.

MINI-TOWER BATTERY REPLACEMENT

CAUTION- A battery can present a risk of electrical shock and high short circuit current. The following precautions should be observed before replacing the batteries:

- Turn off and disconnect the UPS from utility power prior to opening the battery replacement door.
- Remove rings, watches, and other metal objects.
- Use a Phillips (cross head) screwdriver with insulated grips.
- Do not lay tools or other metal objects on top of the batteries.
- If the battery replacement kit is damaged in any way or shows signs of leakage, contact your dealer immediately.
- Do not dispose of batteries in a fire, the batteries may explode.
- If you feel unqualified to replace the battery, do not open the battery door. Call Liebert Technical Support (LTS). World Wide Technical Support numbers are located at the end of this section.

1. Grasp the front bezel near the top and pull forward.
2. Rotate the bezel upward and lay it on top of the UPS.
3. Loosen the two screws at top of the battery door and remove door by pulling it forward slightly and lifting it off. Lay battery door and screws aside for reassembly.
4. **700/1000/1400 VA models:** gently pull battery wiring out and disconnect the two wires [one red (+) and one black(-)].
2200 VA models: pull apart connectors A and B.
5. Grasp white pull-tabs located on sides of the front battery, and pull batteries out of the UPS.
6. Unpack new batteries taking care not to destroy the packing.
7. Slide new batteries into the cavity, noting the white pull-tabs are facing outward.
8. **700/1000/1400 VA models:** connect the battery wires; first red to red, then black to black.
2200 VA models: first connect top battery connector A to bottom battery connector A; then connect UPS connector B to the top battery connector B.
NOTE: There will be a small spark when connecting the black connectors on 700-1400 VA models, and connector B on the 2200 VA model. This is normal and will not harm you or the UPS.
9. Replace battery door by inserting the two metal tabs into the slots at the base of the UPS, and pushing it closed at the top. Tighten the two screws to lock the battery door closed.
10. Flip the bezel back into place, and align bottom clips to the lower slots in the battery door. Once aligned, push bezel back onto the UPS until it latches into position. This may require a gentle tap.
11. Dispose/Recycle of old batteries in accordance with your local laws and regulations.

MINI-TOWER BATTERY REPLACEMENT



Pull bezel forward

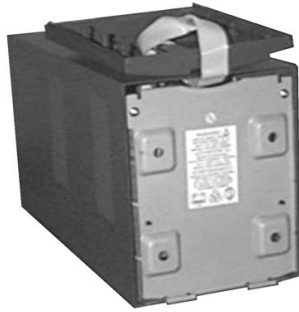

Rotate bezel on top

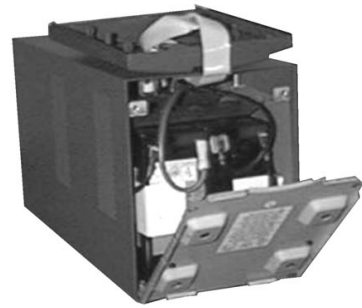

Remove battery door

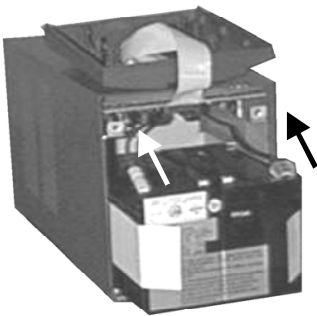

700 VA Model

To Disconnect: Gently pull wiring away

To Connect: Connect red wire to red terminal, then black wire to black terminal by pushing towards connector

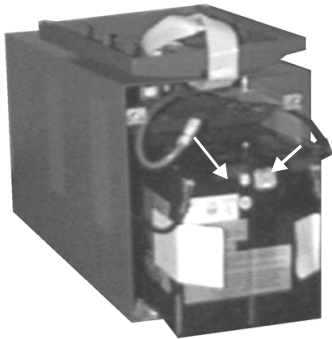
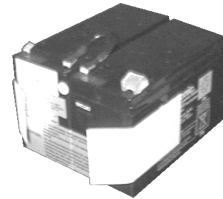

1000/1400 VA Model

To Disconnect: Gently pull wiring away

To Connect: Connect red wire to red terminal, then black wire to black terminal by pushing upward

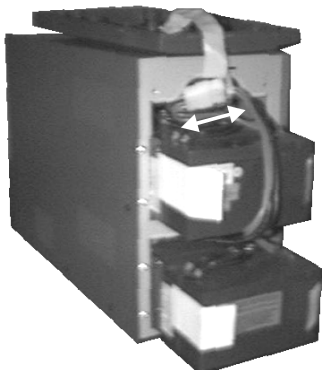
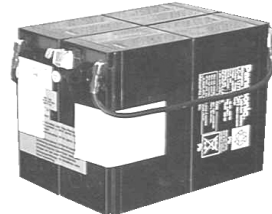

2200 VA Model

To Disconnect:
Pull apart connections A & B

To Connect:
Push connections A together & connections B together

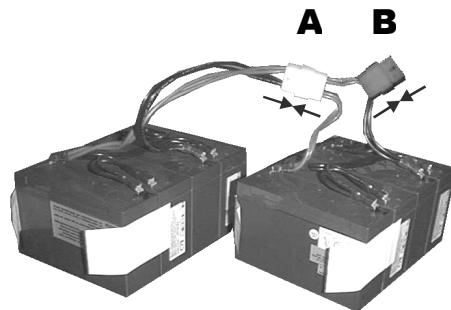

RACKMOUNT BATTERY REPLACEMENT

CAUTION- A battery can present a risk of electrical shock and high short circuit current. The following precautions should be observed before replacing the batteries:

- Turn off and disconnect the UPS from utility power prior to opening the battery replacement door.
- Remove rings, watches, and other metal objects.
- Use a Phillips (cross head) screwdriver with insulated grips.
- Do not lay tools or other metal objects on top of the batteries.
- If the battery replacement kit is damaged in any way or shows signs of leakage, contact your dealer immediately.
- Do not dispose of batteries in a fire, the batteries may explode.

If you feel unqualified to replace the battery, do not open the battery door. Call Liebert Technical Support (LTS). World Wide Technical Support numbers are located at the end of this section.

1. Using a Phillips (cross head) screwdriver loosen the (4) screws around the battery door as in Figure 1. Carefully remove the battery door by pulling it forward. Lay the battery door and screws aside for reassembly.
2. Again using a Phillips (cross head) screwdriver loosen the (4) screws holding the battery retaining plate as in Figure 2. Carefully remove the battery retaining plate by pulling it forward. Lay the battery retaining plate and screws aside for reassembly.
3. **700/1000/1400 VA models:** Gently pull on the white tabs located on both sides of the battery until wiring is exposed (Figure 3). Disconnect red wire (+) (figure 4) and the black wire (-) (figure 5).
2200 VA model: Pull apart the Battery harness connector (Figure 6 & 7). Remove batteries.
4. Unpack new batteries taking care not to destroy the packing.
5. Slide new batteries into the cavity, noting the white pull-tabs are facing outward.
6. **For 700/1000/1400 VA models:** Connect the battery wires; first black to black, then red to red. **For 2200 VA models:** Connect the battery harness connector. Push batteries back into cavity.
NOTE: There will be a small spark when connecting the Red to Red connectors on 700-1400 VA models, and on the 2200 VA model when connecting the battery harness connector. This is normal and will not harm you or the UPS.
7. Replace the Battery retaining plate by inserting the (4) screws into their associated holes. Tighten the (4) screws to secure the battery retaining plate in place.
8. Replace the Battery door by inserting the four (4) screws into their associated holes. Tighten the four (4) screws to secure the battery door in place.
9. Dispose of batteries in accordance with your local laws and regulations.

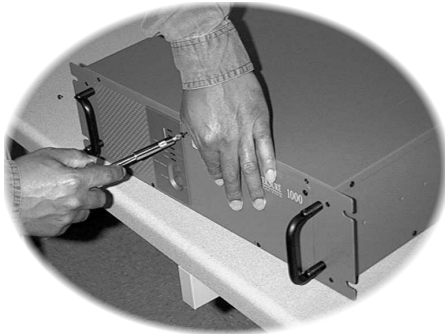

Figure 1

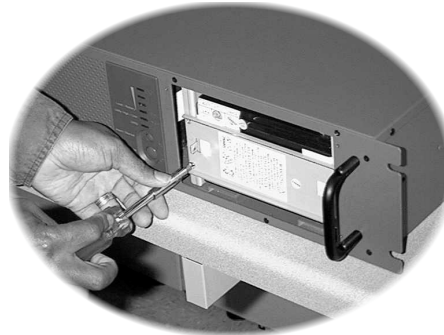

Figure 2

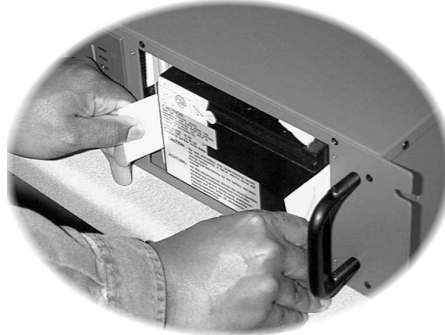

Figure 3

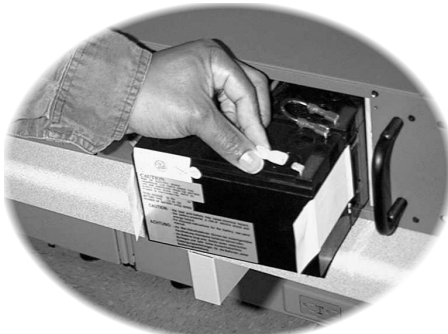

Figure 4

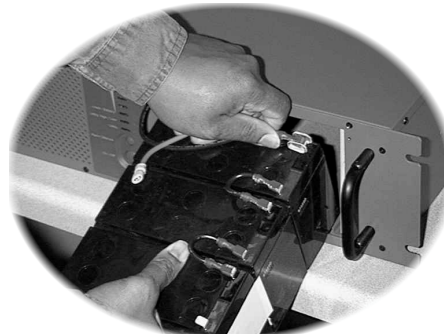

Figure 5



Figure 6

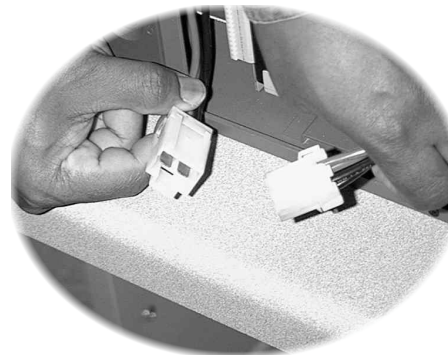
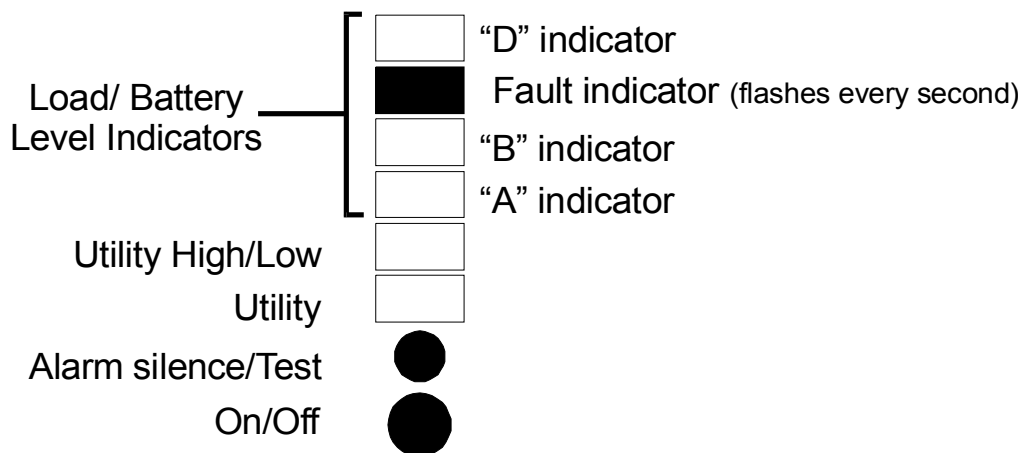

Figure 7

TROUBLESHOOTING

The information below indicates various symptoms a user may encounter in the event the PowerSure™ Interactive UPS develops a problem. Use this information to determine whether external factors cause the problem and how to remedy the situation.

1. The fault indicator will flash every second to indicate the UPS detected a problem.
2. An alarm will sound, alerting that the UPS requires attention.
3. One or more additional load/battery level LED segments will be illuminated to provide a diagnostic aid to the operator, as described below:



- A.** UPS fault (fan failure, battery overcharge)
NOTE: The internal fan operates intermittently as needed
- B.** UPS failed battery test
- D.** UPS shutdown due to output overload time-out
- A&B.** UPS shutdown due to main input relay failure/output short circuit
- A&D.** UPS shutdown due to over temperature condition
- B&D.** UPS shutdown due to command from communication ports
(remote shutdown or SNMP)

The fault indicators will be illuminated indefinitely while battery charger is operational, or for a maximum of 5 minutes while battery charger is not operational.

If a problem persists consult your dealer, or contact Liebert Technical Support (LTS). World Wide Technical Support numbers are located at the end of this section.

TROUBLESHOOTING GUIDE

PROBLEM	CAUSE	SOLUTION
UPS fails to start when On/Off button is pressed	UPS output short circuited or overloaded.	Ensure UPS is off. Disconnect all loads and ensure nothing is lodged in output receptacles. Ensure loads are not defective or shorted internally.
	Internal fuse is blown, indicating internal fault.	Do not attempt to open or service the UPS. Contact your dealer or LTS.
Utility indicator flashing	UPS not plugged in.	UPS is operating in battery mode, make certain UPS is securely plugged into the wall receptacle.
	UPS input protection has opened.	UPS is operating in battery mode. Save data and close applications. Replace UPS input fuse or reset input breaker, then restart UPS .
	Utility voltage out of UPS input range.	UPS is operating in battery mode. Save data and close applications. Ensure utility supply voltage is within acceptable limits for UPS.
UPS has reduced battery time	Batteries not charged.	Keep UPS plugged in continuously at least 24 hours to recharge batteries.
	UPS is overloaded.	Check load level display and remove non essential loads.
	Batteries may not be able to hold a full charge due to age.	Replace batteries. Contact your dealer or LTS for replacement battery kit.
"Fault" indicator and diagnostic LED "A" are illuminated	UPS fan failure or battery overcharge.	UPS requires service. Contact your dealer or LTS.
"Fault" indicator and diagnostic LED "B" are illuminated	UPS failed the battery test.	Replace batteries. Contact your dealer or LTS for replacement battery kit.
UPS shut down. "Fault" indicator and diagnostic LED "D" are illuminated	UPS overloaded or load equipment is faulty.	Check load level display and remove non essential loads. Recalculate load VA and reduce number of loads connected to UPS. Check load equipment for faults.
UPS shuts down with the "Fault" indicator and diagnostic LEDs "A" & "B" are illuminated	UPS shutdown due to internal failure.	UPS requires service. Contact your dealer or LTS.
UPS shuts down with the "Fault" indicator and diagnostic LEDs "A" & "D" are illuminated	UPS shutdown due to an internal over temperature condition.	Ensure UPS is not overloaded, ventilation openings not blocked, or room ambient temperature not excessive. Wait 30 minutes to allow UPS to cool, then restart UPS. If it does not restart, contact your dealer or LTS.
UPS shuts down with the "Fault" indicator and diagnostic LEDs "B" & "D" are illuminated	UPS shutdown due to a command from the communications port(s).	Your UPS has received a signal or command from the attached computer. If this was inadvertent, ensure the communication cable used is correct for your system. For assistance, contact your dealer or LTS.

POWERSURE™ INTERACTIVE TYPICAL BATTERY DISCHARGE CURVES

(Discharge times are at 25° C ambient)

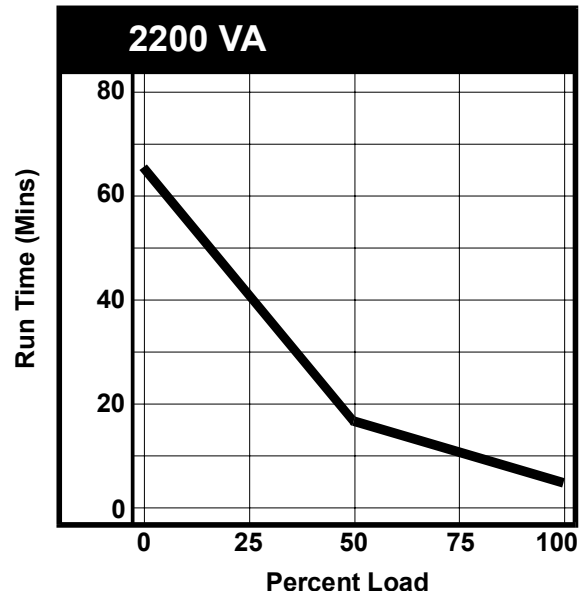
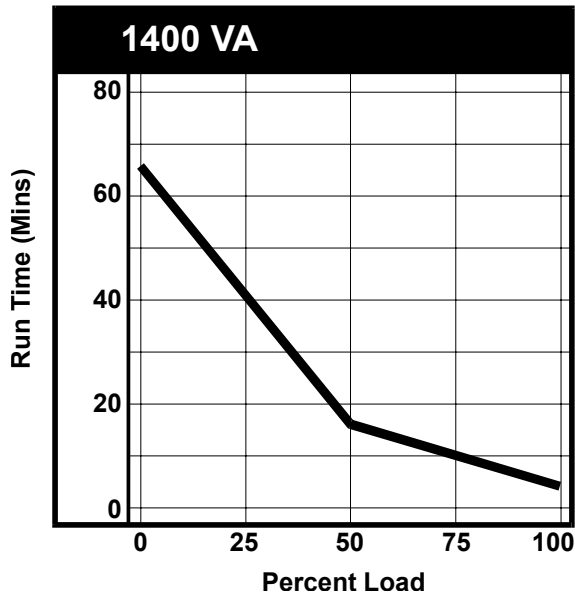
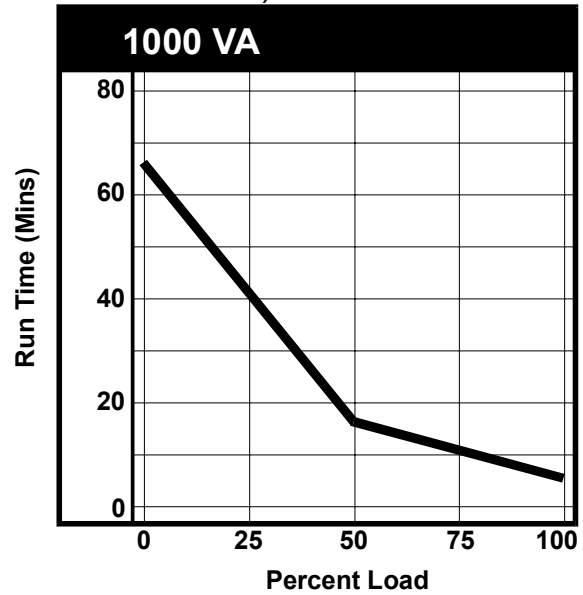
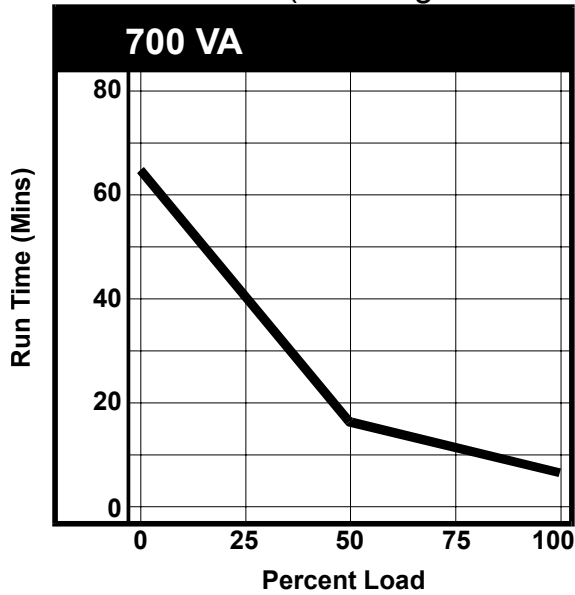

AUDIBLE ALARM CONDITIONS	
CONDITION	ALARM
Battery mode (utility failure)	One short beep every ten seconds; more than two minutes of run time remaining
Low battery	Two short beeps every five seconds; less than two minutes of run time remaining
Battery replacement	Two second beep every minute
UPS output overload	One short beep every second
UPS fault	Continuous tone

FUSE REPLACEMENT PROCEDURES FOR 700 VA MODELS

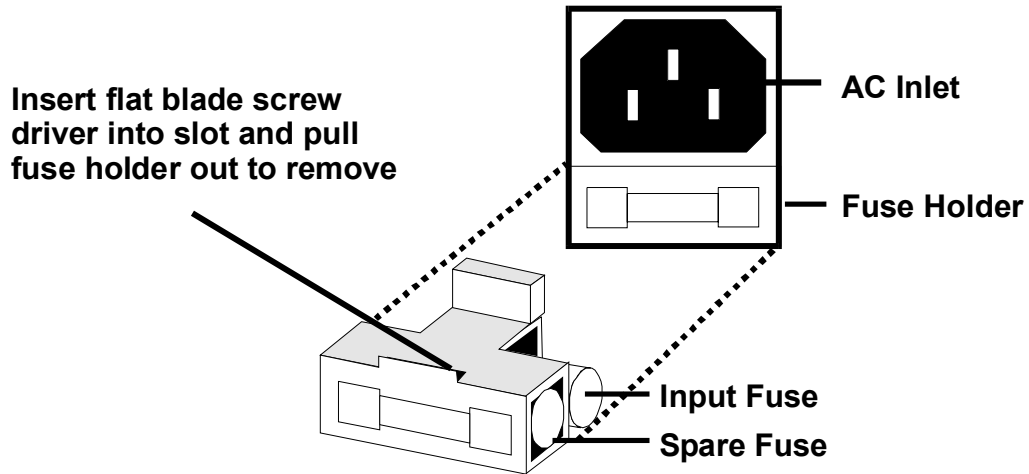

CAUTION: Before changing the supply fuse, turn off the UPS, and unplug the input cord from the AC input power supply and from the UPS.

1. Remove the fuse holder by inserting a flat blade screwdriver into the slot and pulling out as indicated in the figure above.
2. Remove the input fuse.
3. Remove the spare fuse from its position by using the screwdriver to push it out.
4. Place spare fuse in the input fuse position, and replace the fuse holder. The fuse holder will lock into position.
5. Reconnect the input power lead to the UPS, and the input power lead to the input AC supply.
6. Restart the UPS. The UPS is ready for normal operation.

NOTE: For 1000, 1400, and 2200 VA units press the reset circuit protector button.

MINI-TOWER SPECIFICATIONS

Model Number	PS700MT-120	PS1000MT-120	PS1400MT-120	PS2200MT-120
Model Rating VA/W	700 / 450	1000 / 670	1400 / 950	2200 / 1600
DIMENSIONS: in (mm)				
Unit W x D x H	5.5 x 14.4 x 7.0 (140 x 365 x 178)	6.8 x 17.5 x 8.9 (172 x 447 x 227)	6.8 x 17.5 x 8.9 (172 x 447 x 227)	7.6 x 20.1 x 13.2 (194 x 511 x 336)
Shipping W x D x H	10.5 x 19.2 x 11.75 (265 x 492 x 300)	12.0 x 22.25 x 14 (307 x 581 x 358)	12.0 x 22.25 x 14 (307 x 581 x 358)	13.0 x 25.0 x 18.5 (330 x 635 x 470)
WEIGHT: lbs (kg)				
Unit	29.9 (13.6)	43.4 (19.7)	49.4 (22.5)	81.7 (37.1)
Shipping	33.1 (15.0)	46.5 (21.1)	52.5 (23.9)	87.0 (39.5)
INPUT AC PARAMETERS				
Voltage Range	120 VAC; -25%, +23%			
Voltage Raise	Maintains output to 120 VAC; -14%, when input is 120 VAC, -25%			
Voltage Lower	Maintains output to 120 VAC; +10%, when input is 120 VAC, +23%			
Frequency	45-55 Hz or 55-65 Hz; auto sensing			
Input Power Cord	6 ft. detachable, w/ NEMA 5-15 P	6 ft. attached, w/ NEMA 5-15 P	6 ft. attached, w/ NEMA 5-15 P	6 ft. attached, w/ NEMA L5-30 P
OUTPUT AC PARAMETERS				
Output Receptacles	(4) 5-15R	(6) 5-15R	(6) 5-15R	(6)5-15R (2)5-20R
Voltage	103 VAC to 132 VAC			
Max. Current Rating	5.8 A	8.3 A	11.67 A	18.3 A
Frequency	50 Hz or 60 Hz			
Waveform	Sinewave			
Utility Mode Overload	200% for > 2 cycles; 110% for > 5 minutes			
Battery Mode Overload	150% for > 1 cycle; 110% for > 30 seconds			
BATTERY PARAMETERS				
Type	Valve-regulated, nonspillable, lead acid			
Qty. x Voltage x Rating	2 x 12V x 7.0 or 7.2 AH	3 x 12V x 7.0 or 7.2 AH	4 x 12V x 7.0 or 7.2 AH	8 x 6V x 12 AH
Batt. Mfg./ Part Number	CSB: GP1270F2 or Panasonic LC-R127R2CH1			Panasonic: LC-R0612CH1
Transfer Time	2-6 ms typical			
Back-up Time	See Typical Battery Discharge Curves			
Recharge Time	3 Hours	3 Hours	5 Hours	3 Hours
	to 95% capacity, after full discharge into 100% load			
ENVIRONMENTAL				
Operating Temperature	+32° F to + 104° F (0° C to +40° C)			
Storage Temperature	+5° F to + 122° F (-15° C to +50° C)			
Relative Humidity	0% to 95%, non-condensing			
Operating Elevation	Up to 10,000 ft. (3000 m) at 35° C without derating			
Storage Elevation	50,000 ft. (15,000 m) maximum			
Audible Noise	<45 dBA, at 1 meter			
AGENCY				
Safety	UL 1778, c-UL Listed			
RFI/EMI	FCC Part 15, Subpart B, Class A			
Immunity	IEC 801-2, Level 4 / IEC 801-4, Level 4 / IEEE 587 Category A			

RACKMOUNT SPECIFICATIONS

Model Number	PS700RM-120	PS1000RM-120	PS1400RM-120	PS2200RM-120
Model Rating VA/W	700 / 450	1000 / 670	1400 / 950	2200 / 1600
DIMENSIONS: in (mm)				
Unit W x D x H	19 x 18 x 5.25 (483 x 457 x 133)	19 x 18 x 5.25 (483 x 457 x 133)	19 x 18 x 5.25 (483 x 457 x 133)	19 x 18 x 7 (483 x 457 x 178)
Shipping W x D x H	27.5 x 24 x 11 (699 x 610 x 279)	27.5 x 24 x 11 (699 x 610 x 279)	27.5 x 24 x 11 (699 x 610 x 279)	27.5 x 24 x 12 (699 x 610 x 305)
WEIGHT: lbs (kg)				
Unit	41.5 (18.9)	51.29 (23.3)	57.2 (26.0)	86.0 (39.1)
Shipping	50.82 (23.1)	59.85 (27.2)	66.1 (30.0)	95.3 (43.3)
INPUT AC PARAMETERS				
Voltage Range	120 VAC; -25%, +23%			
Voltage Raise	Maintains output to 120 VAC; -14%, when input is 120 VAC, -25%			
Voltage Lower	Maintains output to 120 VAC; +10%, when input is 120 VAC, +23%			
Frequency	45-55 Hz or 55-65 Hz; auto sensing			
Input Power Cord	6 ft. detachable, w/ NEMA 5-15 P	6 ft. attached, w/ NEMA 5-15 P	6 ft. attached, w/ NEMA 5-15 P	6 ft. attached, w/ NEMA L5-30 P
OUTPUT AC PARAMETERS				
Output Receptacles	(6) 5-15R	(6) 5-15R	(6) 5-15R	(6)5-15R (2)5-20R
Voltage	103 VAC to 132 VAC			
Max. Current Rating	5.8 A	8.3 A	11.67 A	18.3 A
Frequency	50 Hz or 60 Hz			
Waveform	Sinewave			
Utility Mode Overload	200% for > 2 cycles; 110% for > 5 minutes			
Battery Mode Overload	150% for > 1 cycle; 110% for > 30 seconds			
BATTERY PARAMETERS				
Type	Valve-regulated, nonspillable, lead acid			
Qty. x Voltage x Rating	2 x 12V x 7.0 or 7.2 AH	3 x 12V x 7.0 or 7.2 AH	4 x 12V x 7.0 or 7.2 AH	8 x 6V x 12 AH
Batt. Mfg./ Part Number	CSB: GP1270F2 or Panasonic LC-R127R2CH1			Panasonic: LC-R0612CH1
Transfer Time	2-6 ms typical			
Back-up Time	See Typical Battery Discharge Curves			
Recharge Time	3 Hours	3 Hours	5 Hours	3 Hours
	to 95% capacity, after full discharge into 100% load			
ENVIRONMENTAL				
Operating Temperature	+32° F to + 104° F (0° C to +40° C)			
Storage Temperature	+5° F to + 122° F (-15° C to +50° C)			
Relative Humidity	0% to 95%, non-condensing			
Operating Elevation	Up to 10,000 ft. (3000 m) at 35° C without derating			
Storage Elevation	50,000 ft. (15,000 m) maximum			
Audible Noise	<45 dBA, at 1 meter			
AGENCY				
Safety	UL 1778, c-UL Listed			
RFI/EMI	FCC Part 15, Subpart B, Class A			
Immunity	IEC 801-2, Level 4 / IEC 801-4, Level 4 / IEEE 587 Category A			



1050 Dearborn Drive Columbus, OH 43229 614-888-0246

PowerSure™ Interactive

700-2200 VA
120 V

Technical Support

U.S.A.....	1-800-222-5877
Outside the U.S.A	614-841-6755
U.K.....	+44 (0) 1793 553355
France	+33 1 4 87 51 52
Germany	+49 89 99 19 220
Italy	+39 2 98250 1
Netherlands.....	+00 31 475 503333
Internet.....	upstech@liebert.com
Web site	http://www.liebert.com
Worldwide FAX Tech Support.....	614-841-5471

The Company Behind The Products

With more than 500,000 installations around the globe, Liebert is the world leader in computer protection systems. Since its founding in 1965, Liebert has developed a complete range of support and protection systems for sensitive electronics:

- Environmental systems: close-control air conditioning from 1.5 to 60 tons.
- Power conditioning and UPS with power ranges from 250 VA to more than 1000 kVA.
- Integrated systems that provide both environmental and power protection in a single, flexible package.
- Monitoring and control — on-site or remote — from systems of any size or location

Service and support, through more than 100 service centers around the world, and a 24-hour Customer Response Center.

While every precaution has been taken to ensure Corporation assumes no responsibility, and disclaims all liability for damages resulting from use of this information or for any errors or omissions.

©1998 Liebert Corporation All rights reserved throughout the world. Specifications subject to change without notice.

® Liebert and the Liebert logo are registered trademarks of Liebert Corporation. All names referred to are trademarks or registered trademarks of their respective owners.

SL-23550 (2/98) Rev. 5.0